



**COMMONWEALTH OF PENNSYLVANIA
DEPARTMENT OF ENVIRONMENTAL PROTECTION
AIR QUALITY PROGRAM**

STATE ONLY NATURAL MINOR OPERATING PERMIT

Issue Date: October 20, 2022

Effective Date: October 20, 2022

Expiration Date: October 20, 2027

In accordance with the provisions of the Air Pollution Control Act, the Act of January 8, 1960, P.L. 2119, as amended, and 25 Pa. Code Chapter 127, the Owner, [and Operator if noted] (hereinafter referred to as permittee) identified below is authorized by the Department of Environmental Protection (Department) to operate the air emission source(s) more fully described in this permit. This Facility is subject to all terms and conditions specified in this permit. Nothing in this permit relieves the permittee from its obligations to comply with all applicable Federal, State and Local laws and regulations.

The regulatory or statutory authority for each permit condition is set forth in brackets. All terms and conditions in this permit are federally enforceable unless otherwise designated.

State Only Permit No: 40-00083

Natural Minor

Federal Tax Id - Plant Code: 27-0835656-1

Owner Information

Name: MULTI-PLASTICS EXTRUSIONS INC

Mailing Address: 600 DIETRICH AVE
HAZLETON, PA 18201-7754

Plant Information

Plant: MULTI PLASTICS EXTRUSIONS INC/HAZLETON

Location: 40 Luzerne County 40002 Hazleton City

SIC Code: 2821 Manufacturing - Plastics Materials And Resins

Responsible Official

Name: THOMAS HUGHES

Title: SITE OPERATIONS MANAGER

Phone: (570) 455 - 1931

Email: tomh@multi-plastics.com

Permit Contact Person

Name: JAMES LUCADAMO

Title: EH & S MGR

Phone: (570) 455 - 1931

Email: jiml@multi-plastics.com

[Signature] _____

MARK J. WEJKSZNER, NORTHEAST REGION AIR PROGRAM MANAGER



SECTION A. Table of Contents

Section A. Facility/Source Identification

Table of Contents
Site Inventory List

Section B. General State Only Requirements

- #001 Definitions.
- #002 Operating Permit Duration.
- #003 Permit Renewal.
- #004 Operating Permit Fees under Subchapter I.
- #005 Transfer of Operating Permits.
- #006 Inspection and Entry.
- #007 Compliance Requirements.
- #008 Need to Halt or Reduce Activity Not a Defense.
- #009 Duty to Provide Information.
- #010 Revising an Operating Permit for Cause.
- #011 Operating Permit Modifications
- #012 Severability Clause.
- #013 De Minimis Emission Increases.
- #014 Operational Flexibility.
- #015 Reactivation
- #016 Health Risk-based Emission Standards and Operating Practice Requirements.
- #017 Circumvention.
- #018 Reporting Requirements.
- #019 Sampling, Testing and Monitoring Procedures.
- #020 Recordkeeping.
- #021 Property Rights.
- #022 Alternative Operating Scenarios.
- #023 Reporting
- #024 Report Format

Section C. Site Level State Only Requirements

- C-I: Restrictions
- C-II: Testing Requirements
- C-III: Monitoring Requirements
- C-IV: Recordkeeping Requirements
- C-V: Reporting Requirements
- C-VI: Work Practice Standards
- C-VII: Additional Requirements
- C-VIII: Compliance Certification
- C-IX: Compliance Schedule

Section D. Source Level State Only Requirements

- D-I: Restrictions
- D-II: Testing Requirements
- D-III: Monitoring Requirements
- D-IV: Recordkeeping Requirements
- D-V: Reporting Requirements
- D-VI: Work Practice Standards
- D-VII: Additional Requirements

Note: These same sub-sections are repeated for each source!

Section E. Source Group Restrictions

- E-I: Restrictions



SECTION A. Table of Contents

- E-II: Testing Requirements
- E-III: Monitoring Requirements
- E-IV: Recordkeeping Requirements
- E-V: Reporting Requirements
- E-VI: Work Practice Standards
- E-VII: Additional Requirements

Section F. Alternative Operating Scenario(s)

- F-I: Restrictions
- F-II: Testing Requirements
- F-III: Monitoring Requirements
- F-IV: Recordkeeping Requirements
- F-V: Reporting Requirements
- F-VI: Work Practice Standards
- F-VII: Additional Requirements

Section G. Emission Restriction Summary

Section H. Miscellaneous

**SECTION A. Site Inventory List**

Source ID	Source Name	Capacity/Throughput	Fuel/Material
102	J LINE	3,600.000 Lbs/HR	POLYSTYRENE SHEET
103	L LINE	1,600.000 Lbs/HR	POLYSTYRENE SHEET
104	K LINE	3,000.000 Lbs/HR	POLYSTYRENE SHEET
105	PET LINE	3,000.000 Lbs/HR	PET MATERIAL
106	H LINE	2,500.000 Lbs/HR	POLYSTYRENE SHEET
107	REPELLETIZER (LINE R-1)	2,000.000 Lbs/HR	POLYSTYRENE
108	X LINE	3,500.000 Lbs/HR	PET (HIPS - 3400 LBS/HR)
109	R & D LINE	438.000 Lbs/HR	POLYSTYRENE; PET
111	POLYMERIZATION PLANT #2	7,500.000 Lbs/HR	POLYSTYRENE
112	REPELLETIZER (LINE R-2)	1,500.000 Lbs/HR	POLYSTYRENE
114	EMERGENCY GENERATOR		
115	STORAGE TANKS		
116	R LINE	1,600.000 Lbs/HR	PET MATERIAL
C01H	CYCLONE COLLECTOR - H LINE - #79		
C01J	CYCLONE COLLECTOR - J LINE #105		
C01K	CYCLONE COLLECTOR - K - LINE #29		
C01L	CYCLONE COLLECTOR - L LINE		
C01P	PET LINE CYCLONE		
C01P2	THERMAL OXIDIZER - PLANT 2		
C01R	CYCLONE COLLECTOR - R LINE		
C01R1	REPELLETIZER CYCLONE		
C01R2	REPELLETIZER CYCLONE		
C01X	CYCLONE COLLECTOR (X LINE - #37)		
C02R	DUST COLLECTOR - R LINE		
C02R1	REPELLETIZER CYCLONE		
C02X	CYCLONE COLLECTOR (X LINE - #35)		
C03R1	REPELLETIZER CYCLONE		
C04R1	REPELLETIZER DUST COLLECTOR		
C04X	CYCLONE COLLECTOR (X LINE - #36)		
FML01	NATURAL GAS		
FML02	DIESEL FUEL		
S011	K LINE OVEN VENT - STACK #11		
S01P2	THERMAL OXIDIZER STACK		
S025	K LINE DIE VENT - STACK #25		
S027	K LINE OVEN VENT - STACK #27		
S035	X-LINE CYCLONE VENT (#35)		
S036	X-LINE CYCLONE VENT (#36)		
S037	X-LINE CYCLONE VENT (#37)		
S052	CORONA TREATER FILTER VENT - STACK #52		
S058	L-LINE OVEN VENT - STACK #58		

**SECTION A. Site Inventory List**

Source ID	Source Name	Capacity/Throughput	Fuel/Material
S062	L-LINE DIE VENT - STACK #62		
S063	L-LINE CYCLONE VENT - STACK #63		
S071L	L-LINE VACUUM PUMP VENT - STACK #71		
S079	H-LINE CYCLONE VENT - STACK #79		
S080	H-LINE DIE VENT - STACK #80		
S084	H - LINE OVEN VENT - STACK #84		
S094	REPELLETIZER (R-2) EXTRUDER - DIE VENT		
S096	J-LINE OVEN VENT - STACK #96		
S097	REPELLITIZER (R-2) CYCLONE VENT		
S100	REPELLETIZER DIE VENT STACK		
S102R	REPELLETIZER DRYER VENT STACK		
S104	J-LINE VACCUUM PUMP VENT - STACK #104		
S107	J-LINE DIE VENT - STACK #107		
S109A	R & D LINE DIE VENT		
S111	PET LINE DRYER BLOWER VENT - STACK #111		
S112	PET LINE DIE VENT - STACK #112		
S114	PET LINE DRYER BLOWER VENT - STACK #114		
S116	PET LINE DRYER BLOWER VENT - STACK #116		
S117	PLANT 2 THERMAL HEATER, VACUUM PUMP, DIE VENT		
S119	R LINE DRYER VENT STACK		
S120	R LINE DIE VENT STACK		
Z-115	FUGITIVE TANK EMISSIONS		
Z114	EMERGENCY GENERATOR FUGITIVES		

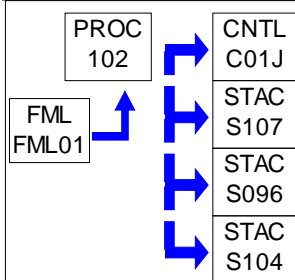
PERMIT MAPS



PERMIT MAPS

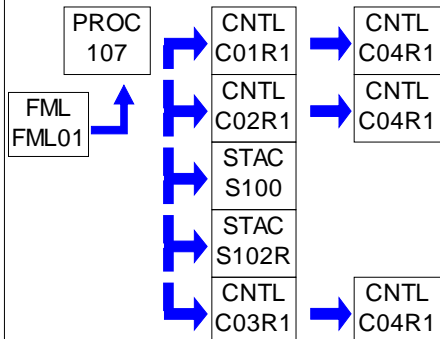
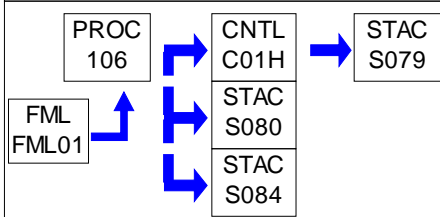
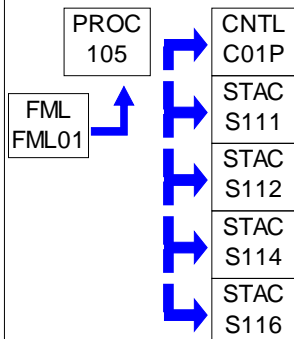
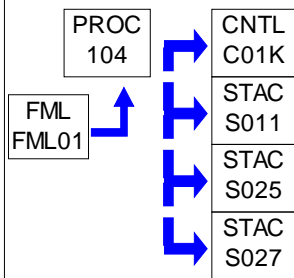
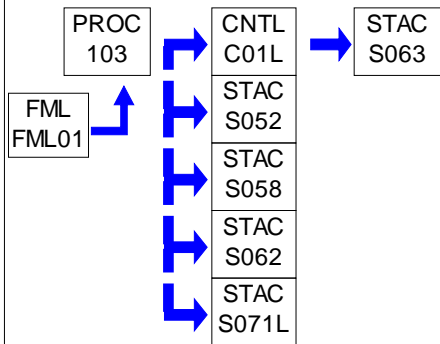



PERMIT MAPS

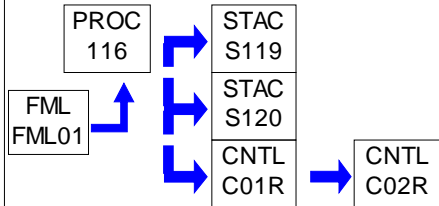
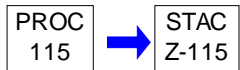
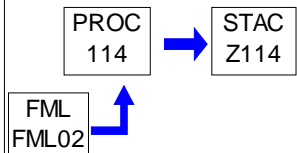
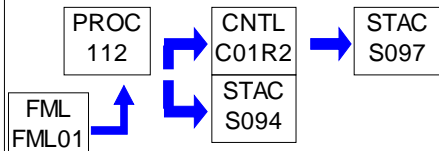
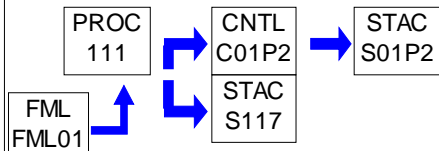
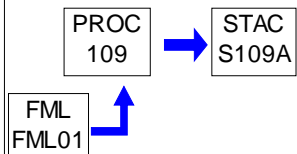
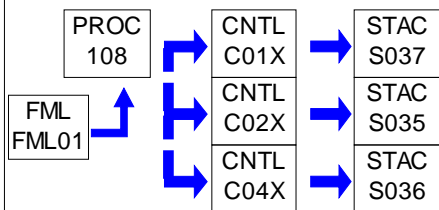

**SECTION B. General State Only Requirements****#001 [25 Pa. Code § 121.1]****Definitions.**

Words and terms that are not otherwise defined in this permit shall have the meanings set forth in Section 3 of the Air Pollution Control Act (35 P.S. § 4003) and in 25 Pa. Code § 121.1.

#002 [25 Pa. Code § 127.446]**Operating Permit Duration.**

- (a) This operating permit is issued for a fixed term of five (5) years and shall expire on the date specified on Page 1 of this permit.
- (b) The terms and conditions of the expired permit shall automatically continue pending issuance of a new operating permit, provided the permittee has submitted a timely and complete application and paid applicable fees required under 25 Pa. Code Chapter 127, Subchapter I and the Department is unable, through no fault of the permittee, to issue or deny a new permit before the expiration of the previous permit.

#003 [25 Pa. Code §§ 127.412, 127.413, 127.414, 127.446 & 127.703(b)]**Permit Renewal.**

- (a) The permittee shall submit a timely and complete application for renewal of the operating permit to the appropriate Regional Air Program Manager. The application for renewal of the operating permit shall be submitted at least six (6) months and not more than 18 months before the expiration date of this permit.
- (b) The application for permit renewal shall include the current permit number, a description of any permit revisions that occurred during the permit term, and any applicable requirements that were promulgated and not incorporated into the permit during the permit term. An application is complete if it contains sufficient information to begin processing the application, has the applicable sections completed and has been signed by a responsible official.
- (c) The permittee shall submit with the renewal application a fee for the processing of the application as specified in 25 Pa. Code § 127.703(b). The fees shall be made payable to "The Commonwealth of Pennsylvania Clean Air Fund" and submitted with the fee form to the respective regional office.
- (d) The renewal application shall also include submission of proof that the local municipality and county, in which the facility is located, have been notified in accordance with 25 Pa. Code § 127.413.
- (e) The application for renewal of the operating permit shall also include submission of supplemental compliance review forms in accordance with the requirements of 25 Pa. Code § 127.412(b) and § 127.412(j).
- (f) The permittee, upon becoming aware that any relevant facts were omitted or incorrect information was submitted in the permit application, shall promptly submit such supplementary facts or corrected information as necessary to address any requirements that become applicable to the source after the permittee submits a complete application, but prior to the date the Department takes action on the permit application.

#004 [25 Pa. Code § 127.703]**Operating Permit Fees under Subchapter I.**

- (a) The permittee shall pay the annual operating permit maintenance fee according to the following fee schedule in either paragraph (1) or (2) in accordance with 25 Pa. Code § 127.703(d) on or before December 31 of each year for the next calendar year.
- (1) For a synthetic minor facility, a fee equal to:
- (i) Four thousand dollars (\$4,000) for calendar years 2021—2025.
 - (ii) Five thousand dollars (\$5,000) for calendar years 2026—2030.
 - (iii) Six thousand three hundred dollars (\$6,300) for the calendar years beginning with 2031.

**SECTION B. General State Only Requirements**

(2) For a facility that is not a synthetic minor, a fee equal to:

- (i) Two thousand dollars (\$2,000) for calendar years 2021—2025.
- (ii) Two thousand five hundred dollars (\$2,500) for calendar years 2026—2030.
- (iii) Three thousand one hundred dollars (\$3,100) for the calendar years beginning with 2031.

(b) The applicable fees shall be made payable to "The Commonwealth of Pennsylvania Clean Air Fund" with the permit number clearly indicated and submitted to the respective regional office.

#005 [25 Pa. Code §§ 127.450 (a)(4) and 127.464]**Transfer of Operating Permits.**

(a) This operating permit may not be transferred to another person, except in cases of transfer-of-ownership that are documented and approved by the Department.

(b) In accordance with 25 Pa. Code § 127.450(a)(4), a change in ownership of the source shall be treated as an administrative amendment if the Department determines that no other change in the permit is required and a written agreement has been submitted to the Department identifying the specific date of the transfer of permit responsibility, coverage and liability between the current and the new permittee and a compliance review form has been submitted to, and the permit transfer has been approved by, the Department.

(c) This operating permit is valid only for those specific sources and the specific source locations described in this permit.

#006 [25 Pa. Code § 127.441 and 35 P.S. § 4008]**Inspection and Entry.**

(a) Upon presentation of credentials and other documents as may be required by law, the permittee shall allow the Department or authorized representatives of the Department to perform the following:

(1) Enter at reasonable times upon the permittee's premises where a source is located or emissions related activity is conducted, or where records are kept under the conditions of this permit;

(2) Have access to and copy, at reasonable times, any records that are kept under the conditions of this permit;

(3) Inspect at reasonable times, any facilities, equipment including monitoring and air pollution control equipment, practices, or operations regulated or required under this permit;

(4) Sample or monitor, at reasonable times, any substances or parameters, for the purpose of assuring compliance with the permit or applicable requirements as authorized by the Clean Air Act, the Air Pollution Control Act, or the regulations promulgated under the Acts.

(b) Pursuant to 35 P.S. § 4008, no person shall hinder, obstruct, prevent or interfere with the Department or its personnel in the performance of any duty authorized under the Air Pollution Control Act or regulations adopted thereunder including denying the Department access to a source at this facility. Refusal of entry or access may constitute grounds for permit revocation and assessment of criminal and/or civil penalties.

(c) Nothing in this permit condition shall limit the ability of the EPA to inspect or enter the premises of the permittee in accordance with Section 114 or other applicable provisions of the Clean Air Act.

#007 [25 Pa. Code §§ 127.441 & 127.444]**Compliance Requirements.**

(a) The permittee shall comply with the conditions of this operating permit. Noncompliance with this permit constitutes a violation of the Clean Air Act and the Air Pollution Control Act and is grounds for one or more of the following:

**SECTION B. General State Only Requirements**

- (1) Enforcement action
- (2) Permit termination, revocation and reissuance or modification
- (3) Denial of a permit renewal application

(b) A person may not cause or permit the operation of a source which is subject to 25 Pa. Code Article III unless the source(s) and air cleaning devices identified in the application for the plan approval and operating permit and the plan approval issued for the source is operated and maintained in accordance with specifications in the applications and the conditions in the plan approval and operating permit issued by the Department. A person may not cause or permit the operation of an air contamination source subject to 25 Pa. Code Chapter 127 in a manner inconsistent with good operating practices.

(c) For purposes of Sub-condition (b) of this permit condition, the specifications in applications for plan approvals and operating permits are the physical configurations and engineering design details which the Department determines are essential for the permittee's compliance with the applicable requirements in this State-Only permit. Nothing in this sub-condition shall be construed to create an independent affirmative duty upon the permittee to obtain a predetermination from the Department for physical configuration or engineering design detail changes made by the permittee.

#008 [25 Pa. Code § 127.441]**Need to Halt or Reduce Activity Not a Defense.**

It shall not be a defense for the permittee in an enforcement action that it was necessary to halt or reduce the permitted activity in order to maintain compliance with the conditions of this permit.

#009 [25 Pa. Code §§ 127.442(a) & 127.461]**Duty to Provide Information.**

(a) The permittee shall submit reports to the Department containing information the Department may prescribe relative to the operation and maintenance of each source at the facility.

(b) The permittee shall furnish to the Department, in writing, information that the Department may request to determine whether cause exists for modifying, revoking and reissuing, or terminating this permit, or to determine compliance with the permit. Upon request, the permittee shall also furnish to the Department copies of records that the permittee is required to maintain in accordance with this permit.

#010 [25 Pa. Code § 127.461]**Revising an Operating Permit for Cause.**

This operating permit may be terminated, modified, suspended or revoked and reissued if one or more of the following applies:

- (1) The permittee constructs or operates the source subject to the operating permit so that it is in violation of the Air Pollution Control Act, the Clean Air Act, the regulations thereunder, a plan approval, a permit or in a manner that causes air pollution.
- (2) The permittee fails to properly or adequately maintain or repair an air pollution control device or equipment attached to or otherwise made a part of the source.
- (3) The permittee has failed to submit a report required by the operating permit or an applicable regulation.
- (4) The EPA determines that the permit is not in compliance with the Clean Air Act or the regulations thereunder.

#011 [25 Pa. Code §§ 127.450, 127.462, 127.465 & 127.703]**Operating Permit Modifications**

(a) The permittee is authorized to make administrative amendments, minor operating permit modifications and significant operating permit modifications, under this permit, as outlined below:

**SECTION B. General State Only Requirements**

(b) Administrative Amendments. The permittee shall submit the application for administrative operating permit amendments (as defined in 25 Pa. Code § 127.450(a)), according to procedures specified in § 127.450 unless precluded by the Clean Air Act or its regulations.

(c) Minor Operating Permit Modifications. The permittee shall submit the application for minor operating permit modifications (as defined 25 Pa. Code § 121.1) in accordance with 25 Pa. Code § 127.462.

(d) Significant Operating Permit Modifications. The permittee shall submit the application for significant operating permit modifications in accordance with 25 Pa. Code § 127.465.

(e) The applicable fees shall be made payable to "The Commonwealth of Pennsylvania Clean Air Fund" with the permit number clearly indicated and submitted to the respective regional office.

#012 [25 Pa. Code § 127.441]**Severability Clause.**

The provisions of this permit are severable, and if any provision of this permit is determined by a court of competent jurisdiction to be invalid or unenforceable, such a determination will not affect the remaining provisions of this permit.

#013 [25 Pa. Code § 127.449]**De Minimis Emission Increases.**

(a) This permit authorizes de minimis emission increases in accordance with 25 Pa. Code § 127.449 so long as the permittee provides the Department with seven (7) days prior written notice before commencing any de minimis emissions increase. The written notice shall:

(1) Identify and describe the pollutants that will be emitted as a result of the de minimis emissions increase.

(2) Provide emission rates expressed in tons per year and in terms necessary to establish compliance consistent with any applicable requirement.

(b) The Department may disapprove or condition de minimis emission increases at any time.

(c) Except as provided below in (d), the permittee is authorized to make de minimis emission increases (expressed in tons per year) up to the following amounts without the need for a plan approval or prior issuance of a permit modification:

(1) Four tons of carbon monoxide from a single source during the term of the permit and 20 tons of carbon monoxide at the facility during the term of the permit.

(2) One ton of NO_x from a single source during the term of the permit and 5 tons of NO_x at the facility during the term of the permit.

(3) One and six-tenths tons of the oxides of sulfur from a single source during the term of the permit and 8.0 tons of oxides of sulfur at the facility during the term of the permit.

(4) Six-tenths of a ton of PM₁₀ from a single source during the term of the permit and 3.0 tons of PM₁₀ at the facility during the term of the permit. This shall include emissions of a pollutant regulated under Section 112 of the Clean Air Act unless precluded by the Clean Air Act, the regulations thereunder or 25 Pa. Code Article III.

(5) One ton of VOCs from a single source during the term of the permit and 5.0 tons of VOCs at the facility during the term of the permit. This shall include emissions of a pollutant regulated under Section 112 of the Clean Air Act unless precluded by the Clean Air Act, the regulations thereunder or 25 Pa. Code Article III.

(6) Other sources and classes of sources determined to be of minor significance by the Department.

(d) In accordance with § 127.14, the permittee is authorized to install the following minor sources without the need for a plan approval or permit modification:

**SECTION B. General State Only Requirements**

(1) Air conditioning or ventilation systems not designed to remove pollutants generated or released from other sources.

(2) Combustion units rated at 2,500,000 or less Btu per hour of heat input.

(3) Combustion units with a rated capacity of less than 10,000,000 Btu per hour heat input fueled by natural gas supplied by a public utility or by commercial fuel oils which are No. 2 or lighter, viscosity less than or equal to 5.82 c St, and which meet the sulfur content requirements of 25 Pa. Code §123.22 (relating to combustion units). For purposes of this permit, commercial fuel oil shall be virgin oil which has no reprocessed, recycled or waste material added.

(4) Space heaters which heat by direct heat transfer.

(5) Laboratory equipment used exclusively for chemical or physical analysis.

(6) Other sources and classes of sources determined to be of minor significance by the Department.

(e) This permit does not authorize de minimis emission increases if the emissions increase would cause one or more of the following:

(1) Increase the emissions of a pollutant regulated under Section 112 of the Clean Air Act except as authorized in Subparagraphs (c)(4) and (5) of this permit condition.

(2) Subject the facility to the prevention of significant deterioration requirements in 25 Pa. Code Chapter 127, Subchapter D and/or the new source review requirements in Subchapter E.

(3) Violate any applicable requirement of this permit, the Air Pollution Control Act, the Clean Air Act, or the regulations promulgated under either of the acts.

(f) Emissions authorized under this permit condition shall be included in the monitoring, recordkeeping and reporting requirements of this permit.

(g) Except for de minimis emission increases, installation of minor sources made pursuant to this permit condition and Plan Approval Exemptions under 25 Pa. Code § 127.14 (relating to exemptions), the permittee is prohibited from making changes or engaging in activities that are not specifically authorized under this permit without first applying for a plan approval. In accordance with § 127.14(b), a plan approval is not required for the construction, modification, reactivation, or installation of the sources creating the de minimis emissions increase.

(h) The permittee may not meet de minimis emission threshold levels by offsetting emission increases or decreases at the same source.

#014 [25 Pa. Code § 127.3]**Operational Flexibility.**

The permittee is authorized to make changes within the facility in accordance with the regulatory provisions outlined in 25 Pa. Code § 127.3 (relating to operational flexibility) to implement the operational flexibility requirements provisions authorized under Section 6.1(i) of the Air Pollution Control Act and the operational flexibility terms and conditions of this permit. The provisions in 25 Pa. Code Chapter 127 which implement the operational flexibility requirements include the following:

(1) Section 127.14 (relating to exemptions)

(2) Section 127.447 (relating to alternative operating scenarios)

(3) Section 127.448 (relating to emissions trading at facilities with Federally enforceable emissions caps)

(4) Section 127.449 (relating to de minimis emission increases)

(5) Section 127.450 (relating to administrative operating permit amendments)

**SECTION B. General State Only Requirements**

(6) Section 127.462 (relating to minor operating permit modifications)

(7) Subchapter H (relating to general plan approvals and general operating permits)

#015 [25 Pa. Code § 127.11]**Reactivation**

(a) The permittee may not reactivate a source that has been out of operation or production for at least one year unless the reactivation is conducted in accordance with a plan approval granted by the Department or in accordance with reactivation and maintenance plans developed and approved by the Department in accordance with 25 Pa. Code § 127.11a(a).

(b) A source which has been out of operation or production for more than five (5) years but less than 10 years may be reactivated and will not be considered a new source if the permittee satisfies the conditions specified in 25 Pa. Code § 127.11a(b).

#016 [25 Pa. Code § 127.36]**Health Risk-based Emission Standards and Operating Practice Requirements.**

(a) When needed to protect public health, welfare and the environment from emissions of hazardous air pollutants from new and existing sources, the permittee shall comply with the health risk-based emission standards or operating practice requirements imposed by the Department, except as precluded by §§ 6.6(d)(2) and (3) of the Air Pollution Control Act [35 P.S. § 4006.6(d)(2) and (3)].

(b) A person challenging a performance or emission standard established by the Department has the burden to demonstrate that performance or emission standard does not meet the requirements of Section 112 of the Clean Air Act.

#017 [25 Pa. Code § 121.9]**Circumvention.**

No person may permit the use of a device, stack height which exceeds good engineering practice stack height, dispersion technique or other technique which, without resulting in reduction of the total amount of air contaminants emitted, conceals or dilutes an emission of air contaminants which would otherwise be in violation of 25 Pa. Code Article III, except that with prior approval of the Department, the device or technique may be used for control of malodors.

#018 [25 Pa. Code §§ 127.402(d) & 127.442]**Reporting Requirements.**

(a) The permittee shall comply with the applicable reporting requirements of the Clean Air Act, the regulations thereunder, the Air Pollution Control Act and 25 Pa. Code Article III including Chapters 127, 135 and 139.

(b) The permittee shall submit reports to the Department containing information the Department may prescribe relative to the operation and maintenance of any air contamination source.

(c) Reports, test data, monitoring data, notifications and requests for renewal of the permit shall be submitted to the:

Regional Air Program Manager
PA Department of Environmental Protection
(At the address given in the permit transmittal letter, or otherwise notified)

(d) Any records or information including applications, forms, or reports submitted pursuant to this permit condition shall contain a certification by a responsible official as to truth, accuracy and completeness. The certifications submitted under this permit shall require a responsible official of the facility to certify that based on information and belief formed after reasonable inquiry, the statements and information in the documents are true, accurate and complete.

(e) Any records, reports or information submitted to the Department shall be available to the public except for such

**SECTION B. General State Only Requirements**

records, reports or information which meet the confidentiality requirements of § 4013.2 of the Air Pollution Control Act and §§ 112(d) and 114(c) of the Clean Air Act. The permittee may not request a claim of confidentiality for any emissions data generated for the facility.

#019 [25 Pa. Code §§ 127.441(c) & 135.5]**Sampling, Testing and Monitoring Procedures.**

(a) The permittee shall comply with the monitoring, recordkeeping or reporting requirements of 25 Pa. Code Chapter 139 and the other applicable requirements of 25 Pa. Code Article III and additional requirements related to monitoring, reporting and recordkeeping required by the Clean Air Act and the regulations thereunder including the Compliance Assurance Monitoring requirements of 40 CFR Part 64, where applicable.

(b) Unless alternative methodology is required by the Clean Air Act and regulations adopted thereunder, sampling, testing and monitoring required by or used by the permittee to demonstrate compliance with any applicable regulation or permit condition shall be conducted in accordance with the requirements of 25 Pa. Code Chapter 139.

#020 [25 Pa. Code §§ 127.441(c) and 135.5]**Recordkeeping.**

(a) The permittee shall maintain and make available, upon request by the Department, the following records of monitored information:

- (1) The date, place (as defined in the permit) and time of sampling or measurements.
- (2) The dates the analyses were performed.
- (3) The company or entity that performed the analyses.
- (4) The analytical techniques or methods used.
- (5) The results of the analyses.
- (6) The operating conditions as existing at the time of sampling or measurement.

(b) The permittee shall retain records of any required monitoring data and supporting information for at least five (5) years from the date of the monitoring, sample, measurement, report or application. Supporting information includes the calibration data and maintenance records and original strip-chart recordings for continuous monitoring instrumentation, and copies of reports required by the permit.

(c) The permittee shall maintain and make available to the Department upon request, records including computerized records that may be necessary to comply with the reporting, recordkeeping and emission statement requirements in 25 Pa. Code Chapter 135 (relating to reporting of sources). In accordance with 25 Pa. Code Chapter 135, § 135.5, such records may include records of production, fuel usage, maintenance of production or pollution control equipment or other information determined by the Department to be necessary for identification and quantification of potential and actual air contaminant emissions.

#021 [25 Pa. Code § 127.441(a)]**Property Rights.**

This permit does not convey any property rights of any sort, or any exclusive privileges.

#022 [25 Pa. Code § 127.447]**Alternative Operating Scenarios.**

The permittee is authorized to make changes at the facility to implement alternative operating scenarios identified in this permit in accordance with 25 Pa. Code § 127.447.

**SECTION B. General State Only Requirements****#023 [25 Pa. Code §135.3]****Reporting**

(a) If the facility is a Synthetic Minor Facility, the permittee shall submit by March 1 of each year an annual emissions report for the preceding calendar year. The report shall include information for all active previously reported sources, new sources which were first operated during the preceding calendar year, and sources modified during the same period which were not previously reported. All air emissions from the facility should be estimated and reported.

(b) A source owner or operator of a Synthetic Minor Facility may request an extension of time from the Department for the filing of an annual emissions report, and the Department may grant the extension for reasonable cause.

#024 [25 Pa. Code §135.4]**Report Format**

If applicable, the emissions reports shall contain sufficient information to enable the Department to complete its emission inventory. Emissions reports shall be made by the source owner or operator in a format specified by the Department.

**SECTION C. Site Level Requirements****I. RESTRICTIONS.****Emission Restriction(s).****# 001 [25 Pa. Code §123.1]****Prohibition of certain fugitive emissions**

(a) No person may permit the emission into the outdoor atmosphere of fugitive air contaminant from a source other than the following:

- (1) Construction or demolition of buildings or structures.
- (2) Grading, paving and maintenance of roads and streets.
- (3) Use of roads and streets. Emissions from material in or on trucks, railroad cars and other vehicular equipment are not considered as emissions from use of roads and streets.
- (4) Clearing of land.
- (5) Stockpiling of materials.
- (6) Open burning operations.
- (7) Sources and classes of sources other than those identified in paragraphs (1)-(6), for which the operator has obtained a determination from the Department that fugitive emissions from the source, after appropriate control, meet the following requirements:
 - (i) the emissions are of minor significance with respect to causing air pollution; and,
 - (ii) the emissions are not preventing or interfering with the attainment or maintenance of any ambient air quality standard.

002 [25 Pa. Code §123.2]**Fugitive particulate matter**

The permittee may not permit fugitive particulate matter to be emitted into the outdoor atmosphere from a source specified in Site Level Condition #001 if such emissions are visible at the point the emissions pass outside the person's property.

003 [25 Pa. Code §123.31]**Limitations**

A person may not permit the emission into the outdoor atmosphere of any malodorous air contaminants from any source in such a manner that the malodors are detectable outside the property of the person on whose land the source is being operated.

004 [25 Pa. Code §123.41]**Limitations**

A person may not permit the emission into the outdoor atmosphere of visible air contaminants in such a manner that the opacity of the emission is either of the following:

- (1) Equal to or greater than 20% for a period or periods aggregating more than three minutes in any 1 hour.
- (2) Equal to or greater than 60% at any time.

005 [25 Pa. Code §123.42]**Exceptions**

The limitations of 123.41 (relating to limitations) shall not apply to a visible emission in any of the following instances:

- (1) When the presence of uncombined water is the only reason for failure of the emission to meet the limitations.
- (2) When the emission results from the operation of equipment used solely to train and test persons in observing the opacity of visible emissions.
- (3) When the emission results from sources specified in 123.1(a)(1) -- (9) (relating to prohibition of certain fugitive emissions).

**SECTION C. Site Level Requirements****II. TESTING REQUIREMENTS.****# 006 [25 Pa. Code §127.441]****Operating permit terms and conditions.**

If at any time the Department has cause to believe that air contaminant emissions from the aforementioned source(s) may be in excess of the limitations specified in, or established to, any applicable rule or regulation contained in Article III of the Rules and Regulations of the Department of Environmental Protection, the company shall be required to conduct whatever tests are deemed necessary by the Department to determine the actual emission rate(s). Such testing shall be conducted in accordance with the revisions of Chapter 139 of the Rules and Regulations of the Department of Environmental Protection, where applicable, and in accordance with any restrictions or limitations established by the Department at such time as it notifies the company that testing is required.

007 [25 Pa. Code §139.1]**Sampling facilities.**

Upon the request of the Department, the person responsible for a source shall provide adequate sampling ports, safe sampling platforms and adequate utilities for the performance by the Department of tests on such source. The Department will set forth, in the request, the time period in which the facilities shall be provided as well as the specifications for such facilities.

008 [25 Pa. Code §139.11]**General requirements.**

The following are applicable to source tests for determining emissions from stationary sources:

- (1) Performance tests shall be conducted while the source is operating at maximum routine operating conditions or under such other conditions, within the capacity of the equipment, as may be requested by the Department.
- (2) The Department will consider for approval where sufficient information is provided to verify the source conditions existing at the time of the test and where adequate data is available to show the manner in which the test was conducted. Information submitted to the Department shall include, as a minimum all of the following:
 - (i) A thorough source description, including a description of any air cleaning devices and the flue.
 - (ii) Process conditions, for example, the charging rate of raw material or rate of production of final product, boiler pressure, oven temperature, and other conditions which may affect emissions from the process.
 - (iii) The location of the sampling ports.
 - (iv) Effluent characteristics, including velocity, temperature, moisture content, gas density (percentage CO, CO₂, O₂ and N₂), static and barometric pressures.
 - (v) Sample collection techniques employed, including procedures used, equipment descriptions and data to verify that isokinetic sampling for particulate matter collection occurred and that acceptable test conditions were met.
 - (vi) Laboratory procedures and results.
 - (vii) Calculated results.

III. MONITORING REQUIREMENTS.**# 009 [25 Pa. Code §123.43]****Measuring techniques**

Visible emissions may be measured using either of the following:

- (1) A device approved by the Department and maintained to provide accurate opacity measurements.
- (2) Observers, trained and qualified to measure plume opacity with the naked eye or with the aid of any devices approved by the Department.

010 [25 Pa. Code §127.441]**Operating permit terms and conditions.**

(a) The permittee shall monitor the facility once each week for the following:

- (1) Odors, relative to the standard specified in 25 Pa. Code §123.31(b). The permittee shall conduct an evaluation at the facility boundary.

**SECTION C. Site Level Requirements**

(2) Visible emissions, relative to the standards specified in 25 Pa. Code §123.41. The permittee shall conduct a visual evaluation of the emission sources from the facility boundary.

(3) Fugitive particulate matter, relative to the standard specified in 25 Pa. Code §123.2. The permittee shall conduct a visual evaluation at the facility boundary.

(b) Objectionable odors, which may cause annoyance or discomfort to the public noticed at the site property boundaries that are caused, or may be caused, by operations at the site; fugitive particulate matter emitted from the facility and visible at the point the emissions pass beyond the property boundary; or visible emissions in excess of the standards specified in 25 Pa. Code §123.41 shall:

(1) Be investigated.

(2) Be reported to the Program Manager, or individual(s) designated by the permittee.

(c) The Department reserves the right to change the above monitoring requirements at any time.

IV. RECORDKEEPING REQUIREMENTS.**# 011 [25 Pa. Code §127.441]****Operating permit terms and conditions.**

The permittee shall maintain records that include, but not be limited to, all VOC containing compounds used at the facility and emission calculations on the entire facilities VOC emissions.

012 [25 Pa. Code §127.441]**Operating permit terms and conditions.**

(a) The permittee shall keep a logbook of weekly facility inspections performed. The logbook shall include the name of the company representative performing the inspection, the date and time of inspections, any instances of exceedances of visible emissions limitations, visible fugitive emissions limitations and malodorous air emissions limitations, and the name of the manager informed if a potential exceedance is observed. The permittee shall also record any and all corrective action(s) taken to abate each recorded deviation to prevent future occurrences.

(b) These records shall be kept for a five (5) year period and shall be made available to the Department upon request.

V. REPORTING REQUIREMENTS.**# 013 [25 Pa. Code §127.441]****Operating permit terms and conditions.**

The company, within one (1) hour of occurrence, shall notify the Department at (570) 826-2511 of any malfunction, recordkeeping and reporting errors, or other possible non-compliance issues, which result in, or may possibly be resulting in, the emission of air contaminants in excess of the limitations specified in, or established pursuant to, any applicable rule or regulations contained in Article III of the Rules and Regulations of the Department of Environmental Protection. A written report shall be submitted to the Department within five working days following the incident describing the malfunction, recordkeeping and reporting error or other non-compliance issue and the corrective actions being taken. The Department may take enforcement action for any violations of the applicable standards.

014 [25 Pa. Code §127.442]**Reporting requirements.**

(a) Each source shall submit reports to the Department containing information the Department may prescribe relative to the operation and maintenance of the source.

(b) At a minimum, each permit shall incorporate by reference the reporting requirements of the act, the Clean Air Act or the regulations thereunder applicable to the source.

015 [25 Pa. Code §135.3]**Reporting**

(a) A person who owns or operates a source to which this chapter applies, and who has previously been advised by the Department to submit a source report, shall submit by March 1 of each year a source report for the preceding calendar year.

**SECTION C. Site Level Requirements**

The report shall include information for all previously reported sources, new sources which were first operated during the preceding calendar year and sources modified during the same period which were not previously reported.

(b) A person who receives initial notification by the Department that a source report is necessary shall submit an initial source report with 60 days after receiving the notification or by March 1 of the year following the year for which the report is required, whichever is later.

(c) A source owner or operator may request an extension of time from the Department for the filing of a source report, and the Department may grant the extension for reasonable cause.

016 [25 Pa. Code §135.4]**Report format**

Source reports shall contain sufficient information to enable the Department to complete its emission inventory. Source reports shall be made by the source owner or operator in a format specified by the Department.

VI. WORK PRACTICE REQUIREMENTS.**# 017 [25 Pa. Code §123.1]****Prohibition of certain fugitive emissions**

(a) The permittee shall take all reasonable actions to prevent particulate matter from becoming airborne. These actions shall include, but not be limited to, the following:

(1) Use, where possible, of water or chemicals for control of dust in the demolition of buildings or structures, construction operations, the grading of roads, or the clearing of land.

(2) Application of asphalt, oil, water or suitable chemicals on dirt roads, material stockpiles and other surfaces which may give rise to airborne dusts.

(3) Paving and maintenance of roadways.

(4) Prompt removal of earth or other material from paved streets onto which earth or other material has been transported by trucking or earth moving equipment, erosion by water, or other means.

018 [25 Pa. Code §127.441]**Operating permit terms and conditions.**

The company shall maintain and operate the air pollution control equipment and sources in accordance with good engineering practice.

019 [25 Pa. Code §127.444]**Compliance requirements.**

A person may not cause or permit the operation of a source subject to this article unless the source and air cleaning devices identified in the application for the plan approval and operating permit and the plan approval issued to the source are operated and maintained in accordance with specifications in the application and conditions in the plan approval and operating permit issued by the Department. A person may not cause or permit the operation of an air contamination source subject to this chapter in a manner inconsistent with good operating practices.

020 [25 Pa. Code §129.14]**Open burning operations**

(a) Outside of air basins. No person may permit the open burning of material in an area outside of air basins in a manner that:

(1) The emissions are visible, at any time, at the point such emissions pass outside the property of the person on whose land the open burning is being conducted.

(2) Malodorous air contaminants from the open burning are detectable outside the property of the person on whose land the open burning is being conducted.

(3) The emissions interfere with the reasonable enjoyment of life or property.

**SECTION C. Site Level Requirements**

(4) The emissions cause damage to vegetation or property.

(5) The emissions are or may be deleterious to human or animal health.

(b) Exceptions: The requirements of subsections (a) do not apply where the open burning operations result from:

(1) A fire set to prevent or abate a fire hazard, when approved by the Department and set by or under the supervision of a public officer.

(2) A fire set for the purpose of instructing personnel in fire fighting, when approved by the Department.

(3) A fire set for the prevention and control of disease or pests, when approved by the Department.

(c) Clearing and grubbing wastes. The following is applicable to clearing and grubbing wastes:

(1) As used in this subsection the following terms shall have the following meanings:

Air curtain destructor -- A mechanical device which forcefully projects a curtain of air across a pit in which open burning is being conducted so that combustion efficiency is increased and smoke and other particulate matter are contained.

Clearing and grubbing wastes -- Trees, shrubs, and other native vegetation which are cleared from land during or prior to the process of construction. The term does not include demolition wastes and dirt laden roots.

(2) Subsection (a) notwithstanding clearing and grubbing wastes may be burned outside of an air basin, subject to the following limitations:

(i) Upon receipt of a complaint or determination by the Department that an air pollution problem exists, the Department may order that the open burning cease or comply with subsection (b) of this section.

(ii) Authorization for open burning under this paragraph does not apply to clearing and grubbing wastes transported from an air basin for disposal outside of an air basin.

(3) During an air pollution episode, open burning is limited by Chapter 137 (relating to air pollution episodes) and shall cease as specified in such chapter.

VII. ADDITIONAL REQUIREMENTS.**# 021 [25 Pa. Code §121.7]****Prohibition of air pollution.**

No person may permit air pollution as that term is defined in the act (The Air Pollution Control Act (35 P.S. Section 4001-4015)).

022 [25 Pa. Code §127.441]**Operating permit terms and conditions.**

The company shall not impose conditions upon or otherwise restrict the Department's access to the sources and/or any associated air cleaning device(s) and shall allow the Department to have access at any time to the sources and associated air cleaning device(s) with such measuring and recording equipment, including equipment recording visual observations, as the Department deems necessary and proper for performing its duties and for the effective enforcement of the Air Pollution Control Act.

VIII. COMPLIANCE CERTIFICATION.

No additional compliance certifications exist except as provided in other sections of this permit including Section B (relating to State Only General Requirements).

IX. COMPLIANCE SCHEDULE.

No compliance milestones exist.

**SECTION D. Source Level Requirements**

Source ID: 102

Source Name: J LINE

Source Capacity/Throughput: 3,600.000 Lbs/HR POLYSTYRENE SHEET

**I. RESTRICTIONS.****Emission Restriction(s).****# 001 [25 Pa. Code §123.13]****Processes**

No person may permit the emission into the outdoor atmosphere of particulate matter from Source ID 102 in a manner that the concentration of particulate matter in the effluent gas exceeds 0.04 grain per dry standard cubic foot, when the effluent gas volume is less than 150,000 dry standard cubic feet per minute.

002 [25 Pa. Code §123.21]**General**

No person may permit the emission into the outdoor atmosphere of sulfur oxides from any stack of Source 102 in a manner that the concentration of the sulfur oxides, expressed as SO₂, in the effluent gas exceeds 500 parts per million, by volume, dry basis.

Fuel Restriction(s).**# 003 [25 Pa. Code §127.441]****Operating permit terms and conditions.**

Any equipment of Source ID 102 burning fuel shall be fired on gas (natural or LP) only.

II. TESTING REQUIREMENTS.

No additional testing requirements exist except as provided in other sections of this permit including Section B (State Only General Requirements).

III. MONITORING REQUIREMENTS.

No additional monitoring requirements exist except as provided in other sections of this permit including Section B (State Only General Requirements).

IV. RECORDKEEPING REQUIREMENTS.

No additional record keeping requirements exist except as provided in other sections of this permit including Section B (State Only General Requirements).

**SECTION D. Source Level Requirements****V. REPORTING REQUIREMENTS.**

No additional reporting requirements exist except as provided in other sections of this permit including Section B (State Only General Requirements).

VI. WORK PRACTICE REQUIREMENTS.

No additional work practice requirements exist except as provided in other sections of this permit including Section B (State Only General Requirements).

VII. ADDITIONAL REQUIREMENTS.

004 [25 Pa. Code §127.441]

Operating permit terms and conditions.

- (a) Source ID 102 consists of all J Line Polystyrene Extrusion Line equipment including: storage silos, filters, feeders, loaders, hoppers, extruder, die, rollstand, oven, coater, winder, pre-cutter and grinder.
- (b) Particulate matter emissions from Control Device C01J of Source ID 102 are emitted indoors.
- (c) C01J is a cyclone collector.

**SECTION D. Source Level Requirements**

Source ID: 103

Source Name: L LINE

Source Capacity/Throughput: 1,600.000 Lbs/HR

POLYSTYRENE SHEET

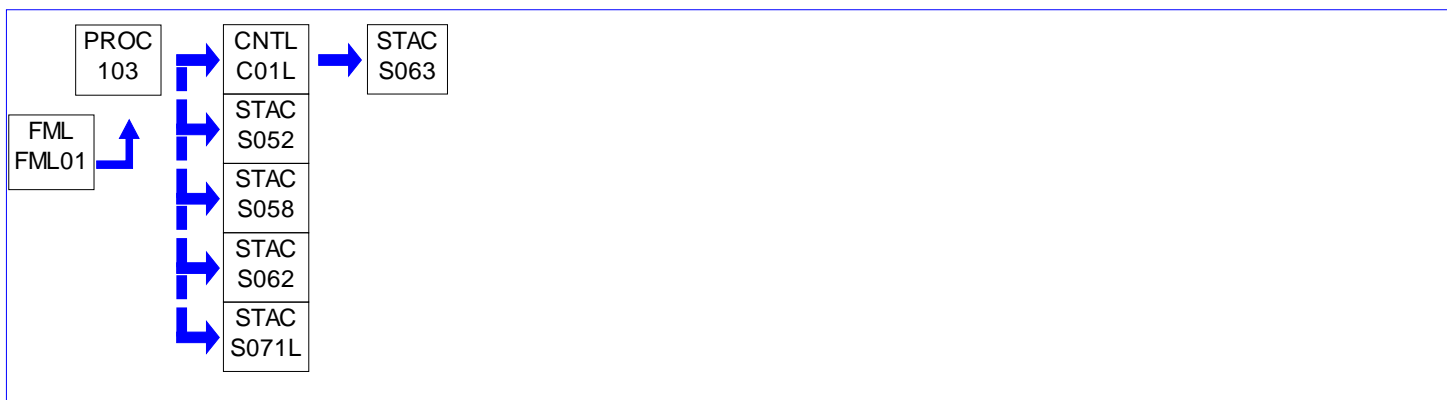
**I. RESTRICTIONS.****Emission Restriction(s).**

001 [25 Pa. Code §123.13]

Processes

No person may permit the emission into the outdoor atmosphere of particulate matter from Source ID 103 in a manner that the concentration of particulate matter in the effluent gas exceeds 0.04 grain per dry standard cubic foot, when the effluent gas volume is less than 150,000 dry standard cubic feet per minute.

002 [25 Pa. Code §123.21]

General

No person may permit the emission into the outdoor atmosphere of sulfur oxides from any stack of Source 103 in a manner that the concentration of the sulfur oxides, expressed as SO₂, in the effluent gas exceeds 500 parts per million, by volume, dry basis.

Fuel Restriction(s).

003 [25 Pa. Code §127.441]

Operating permit terms and conditions.

Any equipment of Source ID 103 burning fuel shall be fired on gas (natural or LP) only.

II. TESTING REQUIREMENTS.

No additional testing requirements exist except as provided in other sections of this permit including Section B (State Only General Requirements).

III. MONITORING REQUIREMENTS.

No additional monitoring requirements exist except as provided in other sections of this permit including Section B (State Only General Requirements).

IV. RECORDKEEPING REQUIREMENTS.

No additional record keeping requirements exist except as provided in other sections of this permit including Section B (State Only General Requirements).

**SECTION D. Source Level Requirements****V. REPORTING REQUIREMENTS.**

No additional reporting requirements exist except as provided in other sections of this permit including Section B (State Only General Requirements).

VI. WORK PRACTICE REQUIREMENTS.

No additional work practice requirements exist except as provided in other sections of this permit including Section B (State Only General Requirements).

VII. ADDITIONAL REQUIREMENTS.

004 [25 Pa. Code §127.441]

Operating permit terms and conditions.

- (a) Source ID 103 consists of all L Line Polystyrene Extrusion Line equipment including: storage silos, filters, feeders, loaders, hoppers, extruder, die, rollstand, tenter oven, corona treater, coater, winder, pre-cutter and grinder.
- (b) Particulate matter emissions from stack #063 of Source ID 103 shall be controlled by C01L.
- (c) C01L is a cyclone collector.

**SECTION D. Source Level Requirements**

Source ID: 104

Source Name: K LINE

Source Capacity/Throughput: 3,000.000 Lbs/HR POLYSTYRENE SHEET

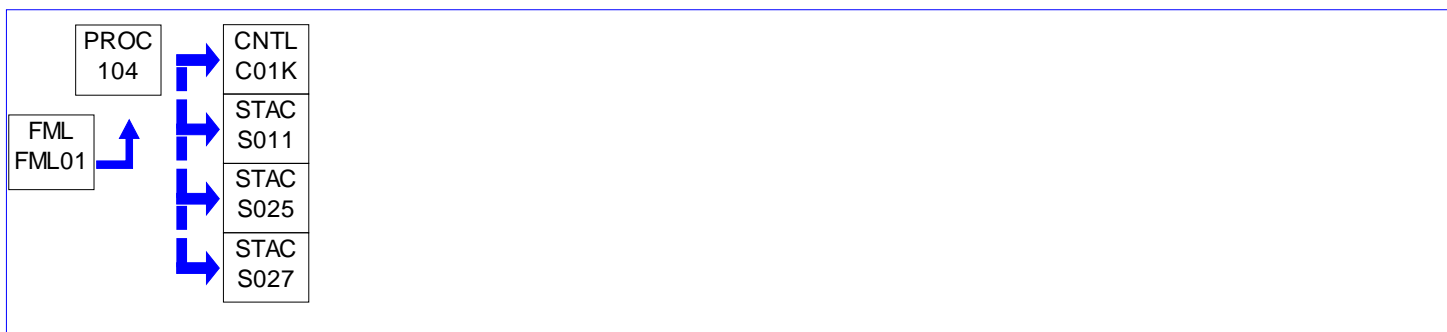
**I. RESTRICTIONS.****Emission Restriction(s).**

001 [25 Pa. Code §123.13]

Processes

No person may permit the emission into the outdoor atmosphere of particulate matter from Source ID 104 in a manner that the concentration of particulate matter in the effluent gas exceeds 0.04 grain per dry standard cubic foot, when the effluent gas volume is less than 150,000 dry standard cubic feet per minute.

002 [25 Pa. Code §123.21]

General

No person may permit the emission into the outdoor atmosphere of sulfur oxides from any stack of Source 104 in a manner that the concentration of the sulfur oxides, expressed as SO₂, in the effluent gas exceeds 500 parts per million, by volume, dry basis.

Fuel Restriction(s).

003 [25 Pa. Code §127.441]

Operating permit terms and conditions.

Any equipment of Source ID 104 burning fuel shall be fired on gas (natural or LP) only.

II. TESTING REQUIREMENTS.

No additional testing requirements exist except as provided in other sections of this permit including Section B (State Only General Requirements).

III. MONITORING REQUIREMENTS.

No additional monitoring requirements exist except as provided in other sections of this permit including Section B (State Only General Requirements).

IV. RECORDKEEPING REQUIREMENTS.

No additional record keeping requirements exist except as provided in other sections of this permit including Section B (State Only General Requirements).

**SECTION D. Source Level Requirements****V. REPORTING REQUIREMENTS.**

No additional reporting requirements exist except as provided in other sections of this permit including Section B (State Only General Requirements).

VI. WORK PRACTICE REQUIREMENTS.

No additional work practice requirements exist except as provided in other sections of this permit including Section B (State Only General Requirements).

VII. ADDITIONAL REQUIREMENTS.

004 [25 Pa. Code §127.441]

Operating permit terms and conditions.

- (a) Source ID 104 consists of all K Line Polystyrene Extrusion Line equipment including: storage silos, filters, feeders, loader, hopper, extruder, vacuum pump, die, rollstand, tenter oven, coater, winder, pre-cutter and grinder.
- (b) Particulate matter emissions from control device C01K of Source ID 104 are emitted indoors.
- (c) C01K is a cyclone collector.

**SECTION D. Source Level Requirements**

Source ID: 105

Source Name: PET LINE

Source Capacity/Throughput: 3,000.000 Lbs/HR PET MATERIAL

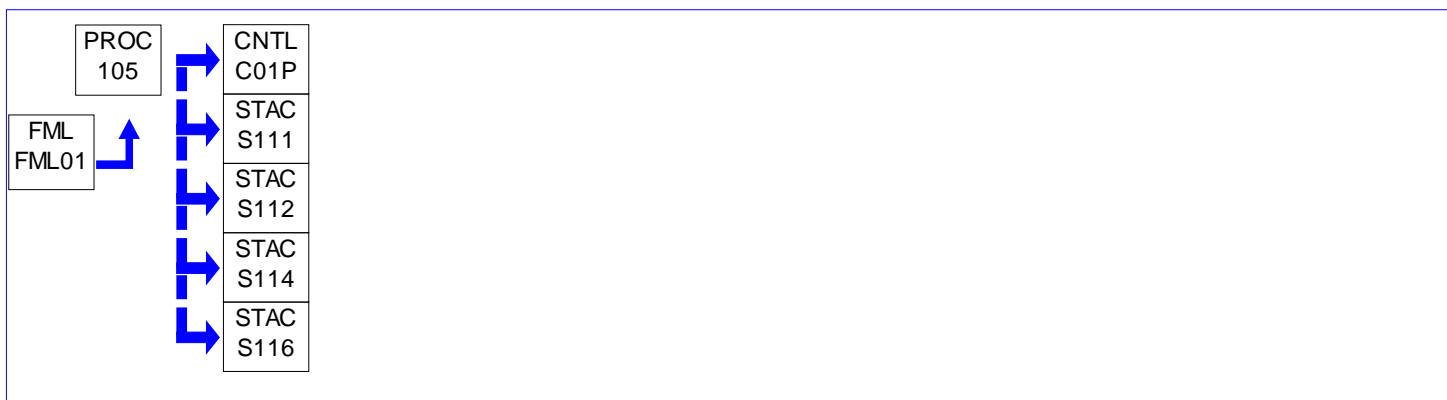
**I. RESTRICTIONS.****Emission Restriction(s).**

001 [25 Pa. Code §123.13]

Processes

No person may permit the emission into the outdoor atmosphere of particulate matter from Source ID 105 in a manner that the concentration of particulate matter in the effluent gas exceeds 0.04 grain per dry standard cubic foot, when the effluent gas volume is less than 150,000 dry standard cubic feet per minute.

002 [25 Pa. Code §123.21]

General

No person may permit the emission into the outdoor atmosphere of sulfur oxides from any stack of Source 105 in a manner that the concentration of the sulfur oxides, expressed as SO₂, in the effluent gas exceeds 500 parts per million, by volume, dry basis.

Fuel Restriction(s).

003 [25 Pa. Code §127.441]

Operating permit terms and conditions.

Any equipment of Source ID 105 burning fuel shall be fired on gas (natural or LP) only.

II. TESTING REQUIREMENTS.

No additional testing requirements exist except as provided in other sections of this permit including Section B (State Only General Requirements).

III. MONITORING REQUIREMENTS.

No additional monitoring requirements exist except as provided in other sections of this permit including Section B (State Only General Requirements).

IV. RECORDKEEPING REQUIREMENTS.

No additional record keeping requirements exist except as provided in other sections of this permit including Section B (State Only General Requirements).

**SECTION D. Source Level Requirements****V. REPORTING REQUIREMENTS.**

No additional reporting requirements exist except as provided in other sections of this permit including Section B (State Only General Requirements).

VI. WORK PRACTICE REQUIREMENTS.

No additional work practice requirements exist except as provided in other sections of this permit including Section B (State Only General Requirements).

VII. ADDITIONAL REQUIREMENTS.

004 [25 Pa. Code §127.441]

Operating permit terms and conditions.

(a) Source ID 105 consists of all PET Co-Extrusion Line equipment including: storage silos, regrinder (gaylord), crystallizer, blender, (3) dryers, dehumidifier, hoppers, 6" and 4.5" extruder, die, rollstand, coater, winder, pre-cutter, edge trim and grinder.

(b) Particulate matter emissions from control device C01P of Source ID 105 are emitted indoors.

(c) C01P is a cyclone collector.

**SECTION D. Source Level Requirements**

Source ID: 106

Source Name: H LINE

Source Capacity/Throughput: 2,500.000 Lbs/HR

POLYSTYRENE SHEET

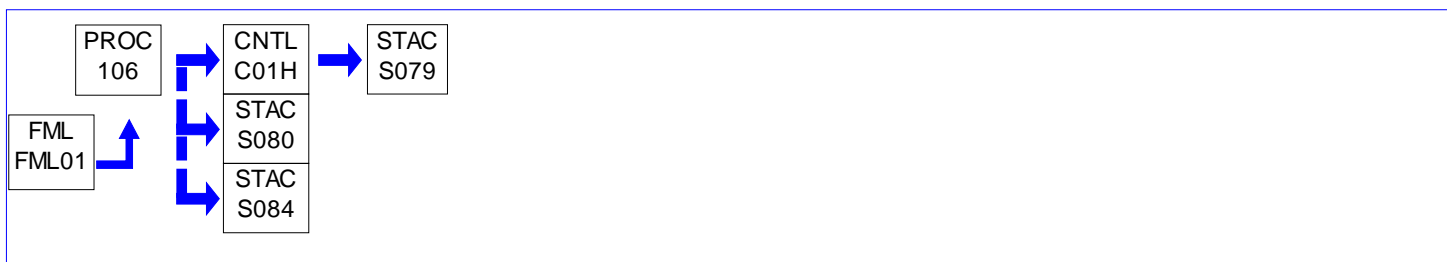
**I. RESTRICTIONS.****Emission Restriction(s).****# 001 [25 Pa. Code §123.13]****Processes**

No person may permit the emission into the outdoor atmosphere of particulate matter from Source ID 106 in a manner that the concentration of particulate matter in the effluent gas exceeds 0.04 grain per dry standard cubic foot, when the effluent gas volume is less than 150,000 dry standard cubic feet per minute.

002 [25 Pa. Code §123.21]**General**

No person may permit the emission into the outdoor atmosphere of sulfur oxides from any stack of Source 106 in a manner that the concentration of the sulfur oxides, expressed as SO₂, in the effluent gas exceeds 500 parts per million, by volume, dry basis.

Fuel Restriction(s).**# 003 [25 Pa. Code §127.441]****Operating permit terms and conditions.**

Any equipment of Source ID 106 burning fuel shall be fired on gas (natural or LP) only.

II. TESTING REQUIREMENTS.

No additional testing requirements exist except as provided in other sections of this permit including Section B (State Only General Requirements).

III. MONITORING REQUIREMENTS.

No additional monitoring requirements exist except as provided in other sections of this permit including Section B (State Only General Requirements).

IV. RECORDKEEPING REQUIREMENTS.

No additional record keeping requirements exist except as provided in other sections of this permit including Section B (State Only General Requirements).

V. REPORTING REQUIREMENTS.

No additional reporting requirements exist except as provided in other sections of this permit including Section B (State Only General Requirements).

**SECTION D. Source Level Requirements****VI. WORK PRACTICE REQUIREMENTS.**

No additional work practice requirements exist except as provided in other sections of this permit including Section B (State Only General Requirements).

VII. ADDITIONAL REQUIREMENTS.

004 [25 Pa. Code §127.441]

Operating permit terms and conditions.

- (a) Source ID 106 consists of all H Line Polystyrene extrusion Line equipment including: storage silos, loader, hopper, blower pump, filter, feeders, extruder, die, rollstand, tenter oven, corona treater, filter, winder, pre-cutter, grinder and cyclone.
- (b) Particulate matter emissions from Stack #079 of Source ID 106 shall be controlled by C01H.
- (c) C01H is a cyclone collector.

**SECTION D. Source Level Requirements**

Source ID: 107

Source Name: REPELLETIZER (LINE R-1)

Source Capacity/Throughput: 2,000.000 Lbs/HR

POLYSTYRENE

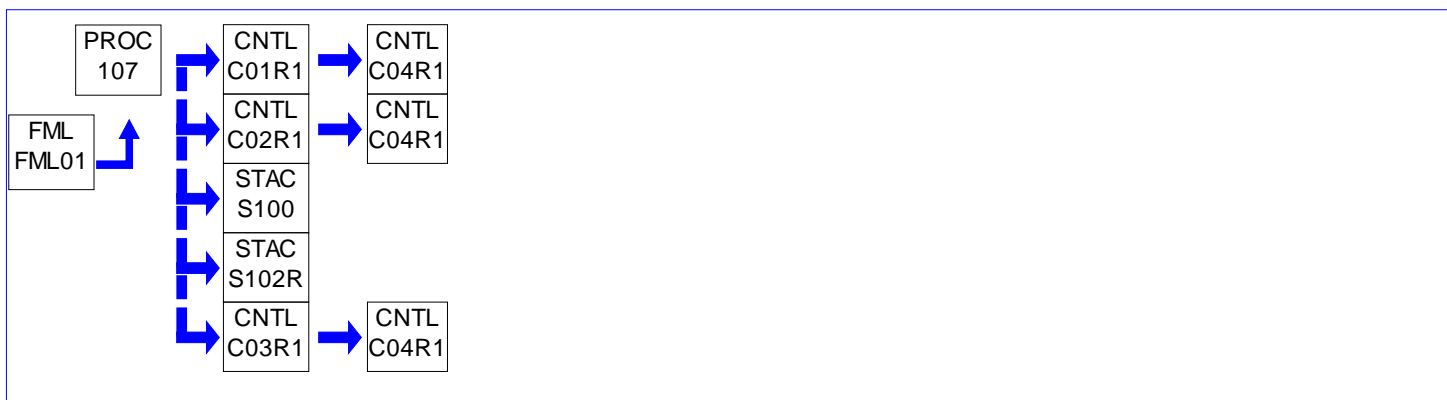
**I. RESTRICTIONS.****Emission Restriction(s).**

001 [25 Pa. Code §123.13]

Processes

No person may permit the emission into the outdoor atmosphere of particulate matter from Source ID 107 in a manner that the concentration of particulate matter in the effluent gas exceeds 0.04 grain per dry standard cubic foot, when the effluent gas volume is less than 150,000 dry standard cubic feet per minute.

002 [25 Pa. Code §123.21]

General

No person may permit the emission into the outdoor atmosphere of sulfur oxides from Source 107 in a manner that the concentration of the sulfur oxides, expressed as SO₂, in the effluent gas exceeds 500 parts per million, by volume, dry basis.

Fuel Restriction(s).

003 [25 Pa. Code §127.441]

Operating permit terms and conditions.

Any equipment of Source ID 107 burning fuel shall be fired on gas (natural or LP) only.

II. TESTING REQUIREMENTS.

No additional testing requirements exist except as provided in other sections of this permit including Section B (State Only General Requirements).

III. MONITORING REQUIREMENTS.

No additional monitoring requirements exist except as provided in other sections of this permit including Section B (State Only General Requirements).

IV. RECORDKEEPING REQUIREMENTS.

No additional record keeping requirements exist except as provided in other sections of this permit including Section B (State Only General Requirements).

**SECTION D. Source Level Requirements****V. REPORTING REQUIREMENTS.**

No additional reporting requirements exist except as provided in other sections of this permit including Section B (State Only General Requirements).

VI. WORK PRACTICE REQUIREMENTS.

No additional work practice requirements exist except as provided in other sections of this permit including Section B (State Only General Requirements).

VII. ADDITIONAL REQUIREMENTS.

004 [25 Pa. Code §127.441]

Operating permit terms and conditions.

(a) Source ID 107 consists of all Polystyrene Repelletizer (R-1) Line equipment including: hopper, H - Line grinder, Cumberland grinder, extruder, die, dryer, hopper bins, silos and Gaylords.

(b) Particulate matter emissions are sent to cyclones C01R1, C02R1, and C03R1 which are routed to dust collector C04R1 and are emitted indoors.

**SECTION D. Source Level Requirements**

Source ID: 108

Source Name: X LINE

Source Capacity/Throughput: 3,500.000 Lbs/HR

PET (HIPS - 3400 LBS/HR)

**I. RESTRICTIONS.****Emission Restriction(s).**

001 [25 Pa. Code §123.13]

Processes

No person may permit the emission into the outdoor atmosphere of particulate matter from Source ID 108 in a manner that the concentration of particulate matter in the effluent gas exceeds 0.04 grain per dry standard cubic foot, when the effluent gas volume is less than 150,000 dry standard cubic feet per minute.

II. TESTING REQUIREMENTS.

No additional testing requirements exist except as provided in other sections of this permit including Section B (State Only General Requirements).

III. MONITORING REQUIREMENTS.

No additional monitoring requirements exist except as provided in other sections of this permit including Section B (State Only General Requirements).

IV. RECORDKEEPING REQUIREMENTS.

No additional record keeping requirements exist except as provided in other sections of this permit including Section B (State Only General Requirements).

V. REPORTING REQUIREMENTS.

No additional reporting requirements exist except as provided in other sections of this permit including Section B (State Only General Requirements).

VI. WORK PRACTICE REQUIREMENTS.

No additional work practice requirements exist except as provided in other sections of this permit including Section B (State Only General Requirements).

VII. ADDITIONAL REQUIREMENTS.

002 [25 Pa. Code §127.441]

Operating permit terms and conditions.

(a) Source ID 108 consists of all X Line Co-Extrusion Line equipment for running PET (Polyester Terephthalate) and HIPS (High Impact Polystyrene) material including:

**SECTION D. Source Level Requirements**

1) (PET Material)

storage silos, regrinder (Gaylord), crystallizer, blender, (3) dryers, dehumidifier, 6" and 4.5" extruder, vacuum pump, die, rollstand, coater, winder, in-line granulation and cyclones.

2) (HIPS Material)

railcar, loader bins, filter, blower/pump, flake hopper, loader bins, (2) 4.5" extruders, vacuum pump, die, rollstand, coater, winder, in-line granulation and cyclones.

(b) Particulate matter emissions from stack #037, #035, and #036 of Source ID 108 shall be controlled by C01X, C02X, and C04X respectively.

(c) C01X, C02X, and C04X are cyclone collectors.

**SECTION D. Source Level Requirements**

Source ID: 109

Source Name: R & D LINE

Source Capacity/Throughput:

438.000 Lbs/HR

POLYSTYRENE; PET

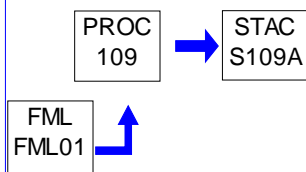
**I. RESTRICTIONS.****Emission Restriction(s).**

001 [25 Pa. Code §123.13]

Processes

No person may permit the emission into the outdoor atmosphere of particulate matter from Source ID 109 in a manner that the concentration of particulate matter in the effluent gas exceeds 0.04 grain per dry standard cubic foot, when the effluent gas volume is less than 150,000 dry standard cubic feet per minute.

II. TESTING REQUIREMENTS.

No additional testing requirements exist except as provided in other sections of this permit including Section B (State Only General Requirements).

III. MONITORING REQUIREMENTS.

No additional monitoring requirements exist except as provided in other sections of this permit including Section B (State Only General Requirements).

IV. RECORDKEEPING REQUIREMENTS.

No additional record keeping requirements exist except as provided in other sections of this permit including Section B (State Only General Requirements).

V. REPORTING REQUIREMENTS.

No additional reporting requirements exist except as provided in other sections of this permit including Section B (State Only General Requirements).

VI. WORK PRACTICE REQUIREMENTS.

No additional work practice requirements exist except as provided in other sections of this permit including Section B (State Only General Requirements).

VII. ADDITIONAL REQUIREMENTS.

002 [25 Pa. Code §127.441]

Operating permit terms and conditions.

Source ID 109 consists of all R & D Line Polystyrene extrusion Line equipment including: virgin polstyrene storage silos, mixer, extruder, die and winder.

**SECTION D. Source Level Requirements**

Source ID: 111

Source Name: POLYMERIZATION PLANT #2

Source Capacity/Throughput: 7,500.000 Lbs/HR POLYSTYRENE

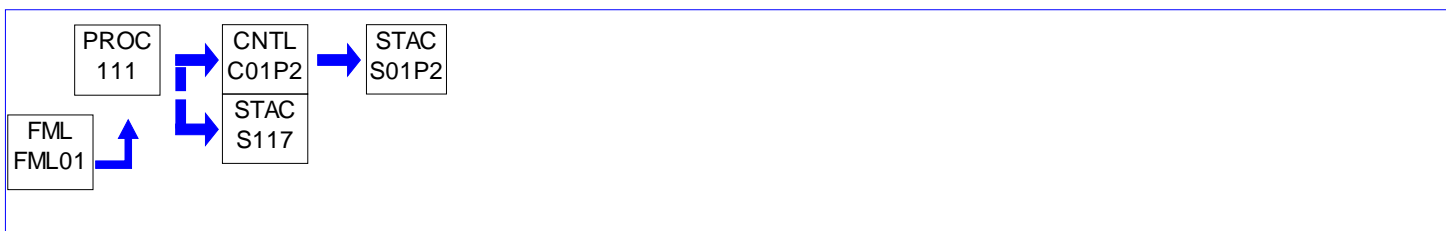
**I. RESTRICTIONS.****Emission Restriction(s).****# 001 [25 Pa. Code §127.441]****Operating permit terms and conditions.**

No person may permit the emission into the outdoor atmosphere of sulfur oxides from a source in a manner that the concentration of the sulfur oxides, expressed as SO₂, in the effluent gas exceeds 500 parts per million, by volume, dry basis.

002 [25 Pa. Code §127.441]**Operating permit terms and conditions.**

No person may permit the emission into the outdoor atmosphere of particulate matter, from the sources, in a manner that the concentration of particulate matter in the effluent gas exceeds .04 grains per dry standard cubic foot, when the effluent gas volume is less than 150,000 dry standard cubic feet per minute.

Fuel Restriction(s).**# 003 [25 Pa. Code §127.441]****Operating permit terms and conditions.**

Any equipment of source 111 burning fuel shall be fired on natural gas with LP backup.

Control Device Efficiency Restriction(s).**# 004 [25 Pa. Code §127.441]****Operating permit terms and conditions.**

The thermal oxidizer shall operate at a temperature of at least 1400 degrees F and a VOC destruction efficiency of at least 95%.

II. TESTING REQUIREMENTS.

No additional testing requirements exist except as provided in other sections of this permit including Section B (State Only General Requirements).

III. MONITORING REQUIREMENTS.

No additional monitoring requirements exist except as provided in other sections of this permit including Section B (State Only General Requirements).

IV. RECORDKEEPING REQUIREMENTS.**# 005 [25 Pa. Code §127.441]****Operating permit terms and conditions.**

Operational records (run status and temperature) for the thermal oxidizer shall be recorded hourly by plant process operators.

**SECTION D. Source Level Requirements****# 006 [25 Pa. Code §127.441]****Operating permit terms and conditions.**

Temperatures shall be recorded whenever the thermal oxidizer is in operation. The records shall be made available to Department personnel upon request. These records shall be maintained for a period of time not less than 5 years.

V. REPORTING REQUIREMENTS.

No additional reporting requirements exist except as provided in other sections of this permit including Section B (State Only General Requirements).

VI. WORK PRACTICE REQUIREMENTS.

No additional work practice requirements exist except as provided in other sections of this permit including Section B (State Only General Requirements).

VII. ADDITIONAL REQUIREMENTS.

No additional requirements exist except as provided in other sections of this permit including Section B (State Only General Requirements).

**SECTION D. Source Level Requirements**

Source ID: 112

Source Name: REPELLETIZER (LINE R-2)

Source Capacity/Throughput: 1,500.000 Lbs/HR POLYSTYRENE

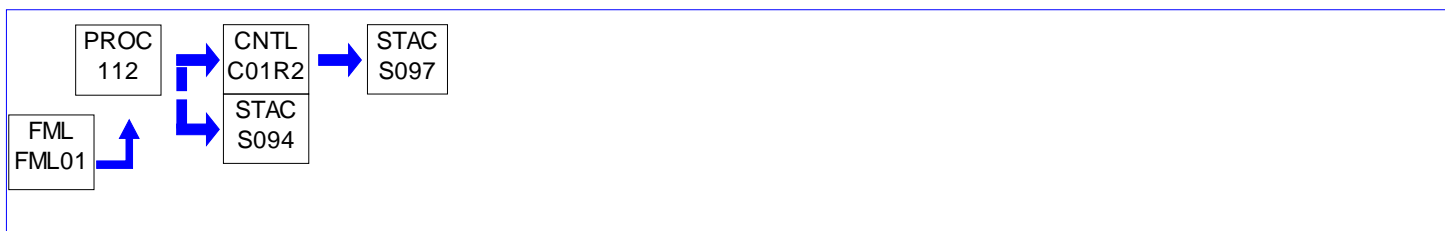
**I. RESTRICTIONS.****Emission Restriction(s).****# 001 [25 Pa. Code §123.13]****Processes**

No person may permit the emission into the outdoor atmosphere of particulate matter from Source ID 112 in a manner that the concentration of particulate matter in the effluent gas exceeds 0.04 grain per dry standard cubic foot, when the effluent gas volume is less than 150,000 dry standard cubic feet per minute.

002 [25 Pa. Code §123.21]**General**

No person may permit the emission into the outdoor atmosphere of sulfur oxides from any stack of Source 112 in a manner that the concentration of the sulfur oxides, expressed as SO₂, in the effluent gas exceeds 500 parts per million, by volume, dry basis.

Fuel Restriction(s).**# 003 [25 Pa. Code §127.441]****Operating permit terms and conditions.**

Any equipment of Source ID 112 burning fuel shall be fired on gas (natural or LP) only.

II. TESTING REQUIREMENTS.

No additional testing requirements exist except as provided in other sections of this permit including Section B (State Only General Requirements).

III. MONITORING REQUIREMENTS.

No additional monitoring requirements exist except as provided in other sections of this permit including Section B (State Only General Requirements).

IV. RECORDKEEPING REQUIREMENTS.

No additional record keeping requirements exist except as provided in other sections of this permit including Section B (State Only General Requirements).

V. REPORTING REQUIREMENTS.

No additional reporting requirements exist except as provided in other sections of this permit including Section B (State Only General Requirements).

**SECTION D. Source Level Requirements****VI. WORK PRACTICE REQUIREMENTS.**

No additional work practice requirements exist except as provided in other sections of this permit including Section B (State Only General Requirements).

VII. ADDITIONAL REQUIREMENTS.

004 [25 Pa. Code §127.441]

Operating permit terms and conditions.

- (a) Source ID 112 consists of all equipment in the Polystyrene Repelletizer (R-2) Line including:
(1) Hopper, (1), (1) extruder, (1) die, (1) dryer, hopper bins, silos, gaylords, (1) J Line grinder and (1) cyclone.
- (b) Particulate matter emissions from stack #097 of Source ID 112 shall be controlled by C01R2.
- (c) C01R2 is a cyclone collector.

**SECTION D. Source Level Requirements**

Source ID: 114

Source Name: EMERGENCY GENERATOR

Source Capacity/Throughput:

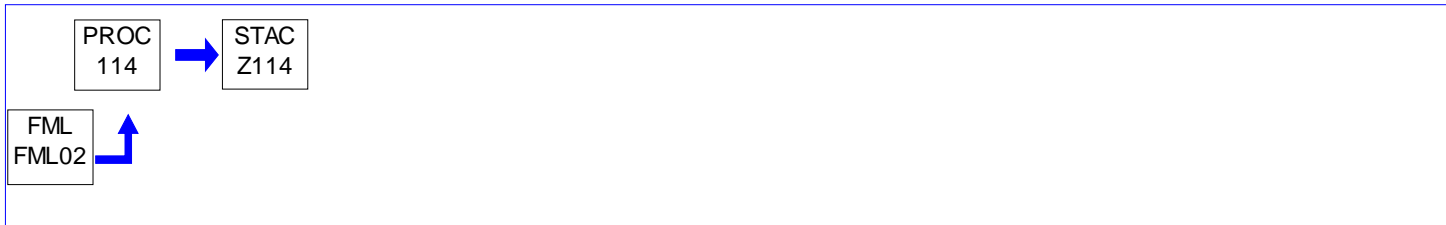
**I. RESTRICTIONS.****Emission Restriction(s).****# 001 [25 Pa. Code §127.441]****Operating permit terms and conditions.**

NOx emissions from Source ID 114 shall be less than 100 lbs/hr, 1000 lbs/day, 2.75 tons per ozone season and 6.6 tons per year on a 12-month rolling basis.

II. TESTING REQUIREMENTS.

No additional testing requirements exist except as provided in other sections of this permit including Section B (State Only General Requirements).

III. MONITORING REQUIREMENTS.

No additional monitoring requirements exist except as provided in other sections of this permit including Section B (State Only General Requirements).

IV. RECORDKEEPING REQUIREMENTS.**# 002 [25 Pa. Code §127.441]****Operating permit terms and conditions.**

The permittee shall keep records of the 12-month rolling sum NOx emissions from the engine to comply with Source ID 114 Condition #001.

V. REPORTING REQUIREMENTS.

No additional reporting requirements exist except as provided in other sections of this permit including Section B (State Only General Requirements).

VI. WORK PRACTICE REQUIREMENTS.**# 003 [25 Pa. Code §127.441]****Operating permit terms and conditions.**

The company shall maintain and operate the emergency generator with good operating practices in the event of power failure or phase loss of Polymerization Plant #2 (Source ID 111).

VII. ADDITIONAL REQUIREMENTS.**# 004 [25 Pa. Code §127.441]****Operating permit terms and conditions.**

This source is subject to all applicable requirements according to 40 CFR Part 60 Subpart IIII and 40 CFR Part 63 Subpart ZZZZ.

40 CFR Part 60.4 requires submission of copies of all requests, reports, application, submittals and other communications

**SECTION D. Source Level Requirements**

to both EPA and the Department. The EPA copies shall be forwarded to:

United States Environmental Protection Agency
Region III, Air Radiation Division
Permits Branch (3AD10)
4 Penn Center
1600 John F. Kennedy Boulevard
Philadelphia, PA 19103

005 [25 Pa. Code §127.441]

Operating permit terms and conditions.

Source ID 114 is a 900kW, diesel-fired Cummins emergency generator located at Polymerization Plant #2 (Source ID 111) per RFD issued 4/21/08.

**SECTION D. Source Level Requirements**

Source ID: 115

Source Name: STORAGE TANKS

Source Capacity/Throughput:

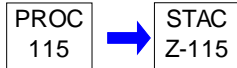
**I. RESTRICTIONS.****Emission Restriction(s).****# 001 [25 Pa. Code §127.441]****Operating permit terms and conditions.**

The permittee shall not store any liquid containing volatile organic compounds (VOCs) with a vapor pressure greater than 1.5 psia under actual storage conditions in any storage tank of Source ID 115.

II. TESTING REQUIREMENTS.

No additional testing requirements exist except as provided in other sections of this permit including Section B (State Only General Requirements).

III. MONITORING REQUIREMENTS.

No additional monitoring requirements exist except as provided in other sections of this permit including Section B (State Only General Requirements).

IV. RECORDKEEPING REQUIREMENTS.**# 002 [25 Pa. Code §127.441]****Operating permit terms and conditions.**

a) The permittee shall keep records of the vapor pressure of the contents stored in each storage tank of Source ID 115.

b) These records shall be kept for a five (5) year period and shall be made available to the Department upon request.

V. REPORTING REQUIREMENTS.

No additional reporting requirements exist except as provided in other sections of this permit including Section B (State Only General Requirements).

VI. WORK PRACTICE REQUIREMENTS.

No additional work practice requirements exist except as provided in other sections of this permit including Section B (State Only General Requirements).

VII. ADDITIONAL REQUIREMENTS.**# 003 [25 Pa. Code §127.441]****Operating permit terms and conditions.**

Source ID 115 consists of eight (8) volatile organic compound fixed roof storage tanks listed below:

-029A, 2950 gallons, verticle fixed roof storage tank, ethylbenzene.

-030A, 19400 gallons, vertical fixed roof storage tank, ethylbenzene, styrene monomer, LMW polystyrene, xylene, styrene oxide.

-037A, 19,400 gallons, vertical fixed roof storage tank, ethylbenzene, styrene monomer.

**SECTION D. Source Level Requirements**

-038A, 19,400 gallons, vertical fixed roof storage tank, ethylbenzene, styrene monomer.

-039A, 71,980 gallons, vertical fixed roof storage tank, styrene.

-040A, 71,890 gallons, vertical fixed roof storage tank, styrene.

-041A, 71,890 gallons, vertical fixed roof storage tank, styrene.

-042A, 71,890 gallons, vertical fixed roof storage tank, styrene.

**SECTION D. Source Level Requirements**

Source ID: 116

Source Name: R LINE

Source Capacity/Throughput: 1,600.000 Lbs/HR PET MATERIAL

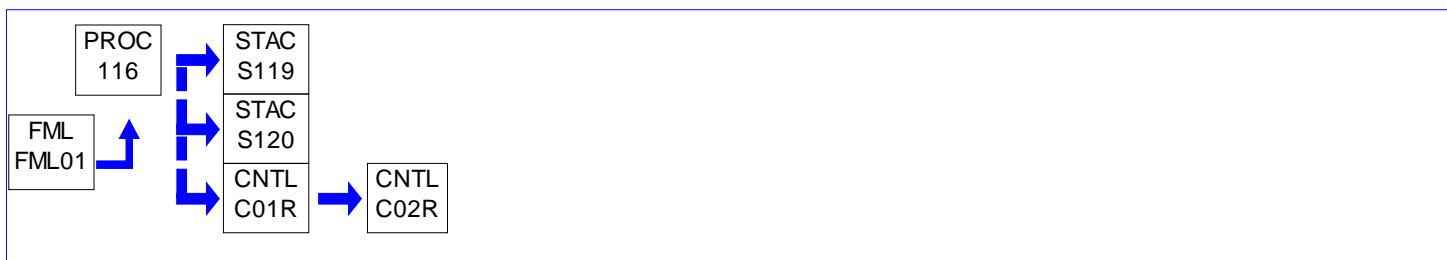
**I. RESTRICTIONS.****Emission Restriction(s).**

001 [25 Pa. Code §123.13]

Processes

No person may permit the emission into the outdoor atmosphere of particulate matter from Source ID 116 in a manner that the concentration of particulate matter in the effluent gas exceeds 0.04 grain per dry standard cubic foot, when the effluent gas volume is less than 150,000 dry standard cubic feet per minute

002 [25 Pa. Code §123.21]

General

No person may permit the emission into the outdoor atmosphere of sulfur oxides from Source 116 in a manner that the concentration of the sulfur oxides, expressed as SO₂, in the effluent gas exceeds 500 parts per million, by volume, dry basis.

Fuel Restriction(s).

003 [25 Pa. Code §127.441]

Operating permit terms and conditions.

Any equipment of Source ID 116 burning fuel shall be fired on gas (natural or LP) only.

II. TESTING REQUIREMENTS.

No additional testing requirements exist except as provided in other sections of this permit including Section B (State Only General Requirements).

III. MONITORING REQUIREMENTS.

No additional monitoring requirements exist except as provided in other sections of this permit including Section B (State Only General Requirements).

IV. RECORDKEEPING REQUIREMENTS.

No additional record keeping requirements exist except as provided in other sections of this permit including Section B (State Only General Requirements).

V. REPORTING REQUIREMENTS.

No additional reporting requirements exist except as provided in other sections of this permit including Section B (State Only General Requirements).

**SECTION D. Source Level Requirements****VI. WORK PRACTICE REQUIREMENTS.**

No additional work practice requirements exist except as provided in other sections of this permit including Section B (State Only General Requirements).

VII. ADDITIONAL REQUIREMENTS.

004 [25 Pa. Code §127.441]

Operating permit terms and conditions.

- (a) Source ID 116 consists of all R Line PET Extrusion Line equipment including: edge trim system with grinder, blender, hopper, extruder, die, winder, crane, and up-ender.
- (b) Particulate matter emissions are sent to cyclone C01R which is routed to dust collector C02R and are emitted indoors.



SECTION E. Source Group Restrictions.



SECTION F. Alternative Operation Requirements.

No Alternative Operations exist for this State Only facility.

**SECTION G. Emission Restriction Summary.**

No emission restrictions listed in this section of the permit.



SECTION H. Miscellaneous.

The operating permit application for the facility was received by the Department on March 15, 2022. The facility is required to pay an Annual Operating Permit Maintenance Fee in accordance with Pennsylvania Code, Title 25, Chapter 127, Section 127.703. The Annual Maintenance Fee is due on or before December 31 of each year for the next calendar year.

The facility operated under operating permits 40-313-030D / 40-313-036 GP / 40-313-037GP / 40-313-038GP / 40-313-039GP / 40-313-040GP / 40-313-041GP / 40-313-042GP, 40-313-043GP, and PA #40-313-047 before issuance of this permit.

This is a State Only Natural Minor operating permit facility.

Source ID 107 is modified to recycle exhaust air from three (3) existing cyclones through a single dust collector and then returned to the facility as indoor air. Plan Approval was not required for this modification as per Department RFD #45-0762.

Source ID 116 has been added to the permit and is to recycle exhaust air from a cyclone through a single dust collector and then returned to the facility as indoor air. Plan Approval was not required for this source and controls per Department RFD #45-0810.

Plan Approval 40-00083A is included in this State Only permit.

Request for Determination (RFD) #9724 was approved on May 27, 2022 for the installation of extrusion line known as M-Line and has a capacity of 3,300 pounds per hour. This line replaced Can Line (Source ID 101).

Source ID 111 - The TBC (4-Tert-Butylcaterol) short stop/chain termination injection system is no longer used and has been removed from renewal operating permit.



***** End of Report *****
